

NPN SILICON EPITAXIAL TRANSISTOR
MP-3

DESCRIPTION

2SC3632-Z is designed for High Voltage Switching, especially in Hybrid Integrated Circuits.

FEATURES

- High Voltage $V_{CE0} = 600$ V
- High Speed $t_r < 0.5 \mu s$
- Complement to 2SA1413-Z

QUALITY GRADE

Standard

Please refer to "Quality grade on NEC Semiconductor Devices" (Document number IEI-1209) published by NEC Corporation to know the specification of quality grade on the devices and its recommended applications.

ABSOLUTE MAXIMUM RATINGS ($T_a = 25 \text{ }^\circ\text{C}$)

Collector to Base Voltage	V_{CB0}	600	V
Collector to Emitter Voltage	V_{CE0}	600	V
Emitter to Base Voltage	V_{EB0}	7	V
Collector Current (DC)	I_c	1	A
Collector Current (Pulse)*	I_c	2	A
Total Power Dissipation ($T_a = 25 \text{ }^\circ\text{C}$)**	P_T	2.0	W
Junction Temperature	T_j	150	$^\circ\text{C}$
Storage Temperature	T_{stg}	-55 to +150	$^\circ\text{C}$

* $PW \leq 10$ ms, Duty Cycle ≤ 50 %

** When mounted on ceramic substrate of $7.5 \text{ cm}^2 \times 0.7$ mm

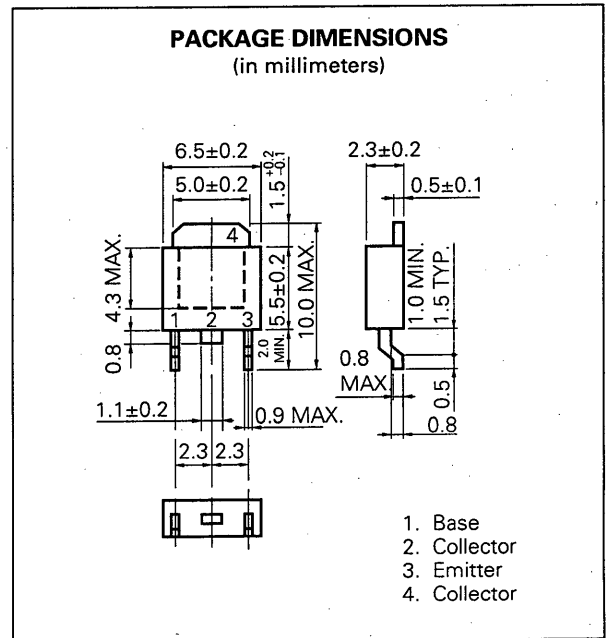

ELECTRICAL CHARACTERISTICS (T_a = 25 °C)

CHARACTERISTIC	SYMBOL	MIN.	TYP.	MAX.	UNIT	TEST CONDITIONS
Collector Cutoff Current	I _{cBO}			10	μA	V _{CB} = 600 V, I _E = 0
Emitter Cutoff Current	I _{EBO}			10	μA	V _{EB} = 7.0 V, I _C = 0
DC Current Gain	h _{FE1} *	30	55	120		V _{CE} = 5.0 V, I _C = 100 mA
DC Current Gain	h _{FE2} *	5	7			V _{CE} = 5.0 V, I _C = 500 mA
Collector Saturation Voltage	V _{CE(sat)} *		0.35	1.0	V	I _C = 400 mA, I _B = 80 mA
Base Saturation Voltage	V _{BE(sat)} *		0.9	1.2	V	I _C = 400 mA, I _B = 80 mA
Gain Bandwidth Product	f _T		30		MHz	V _{CE} = 5.0 V, I _E = -50 mA
Output Capacitance	C _{ob}		14		pF	V _{CB} = 10 V, I _E = 0, f = 1.0 MHz
Turn-on Time	t _{on}		0.1	0.5	μs	I _C = 0.5 A, R _L = 500 Ω I _{B1} = -I _{B2} = 0.1 A V _{CC} = 250 V
Storage Time	t _{stg}		4.0	5.0	μs	
Fall Time	t _f		0.2	0.5	μs	

* Pulsed: PW ≤ 350 μs, Duty Cycle ≤ 2 %

h_{FE} Classification

MARKING	M	L	K
h _{FE1}	30 to 60	40 to 80	60 to 120

TYPICAL CHARACTERISTICS (T_a = 25 °C)

TOTAL POWER DISSIPATION vs. AMBIENT TEMPERATURE

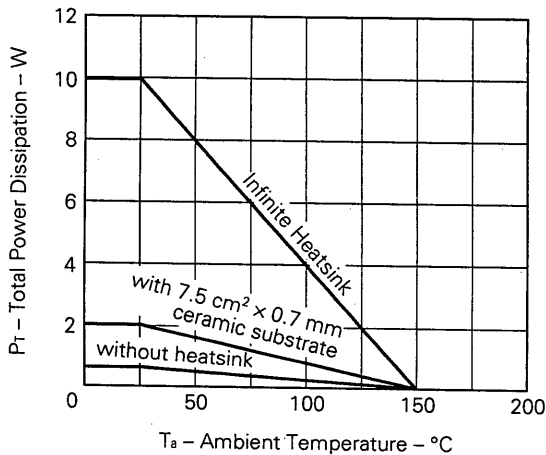

FORWARD BIAS SAFE OPERATING AREA

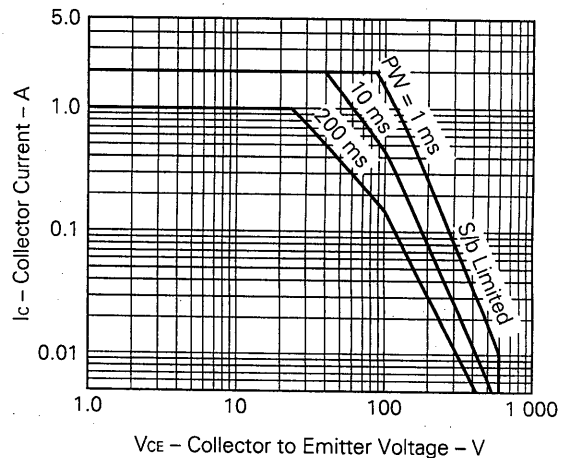

REVERSE BIAS SAFE OPERATING AREA

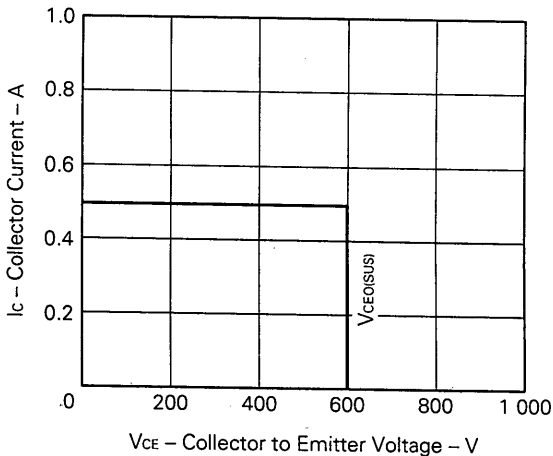

COLLECTOR CURRENT vs. COLLECTOR TO EMITTER VOLTAGE

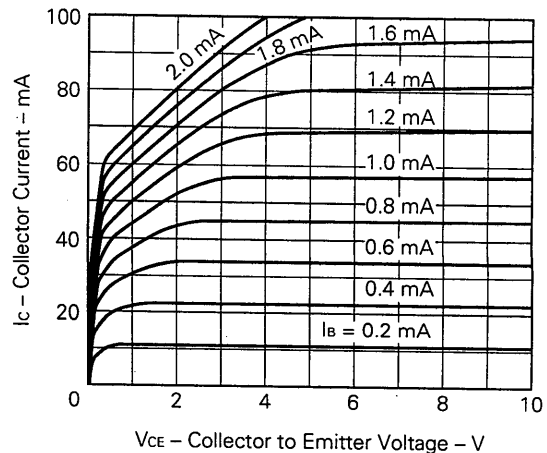

COLLECTOR CURRENT vs. BASE TO EMITTER VOLTAGE

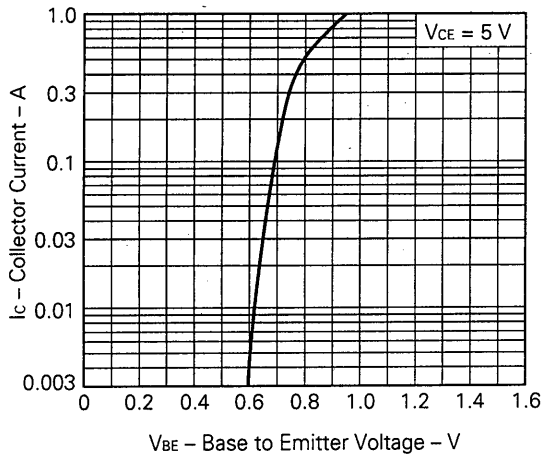

DC CURRENT GAIN vs. COLLECTOR CURRENT

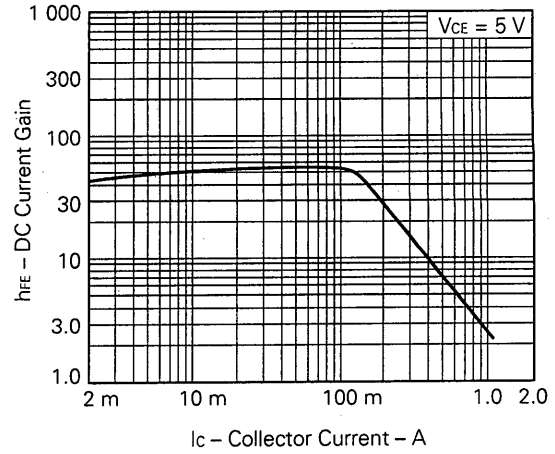

COLLECTOR AND BASE SATURATION VOLTAGE vs. COLLECTOR CURRENT

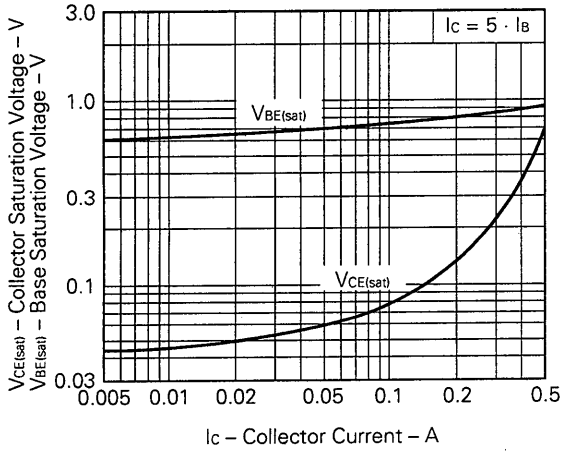

TURN OFF TIME vs. COLLECTOR CURRENT

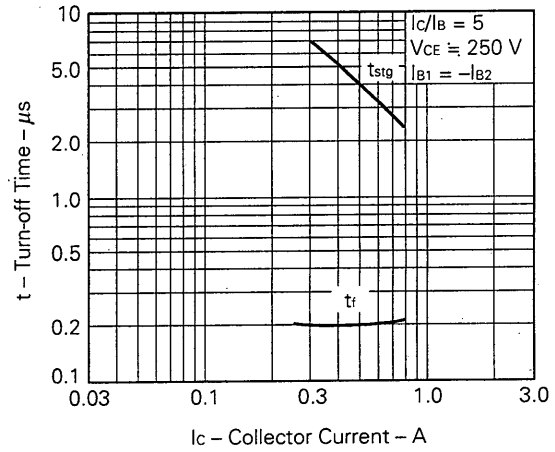

GAIN BANDWIDTH PRODUCT vs. COLLECTOR CURRENT

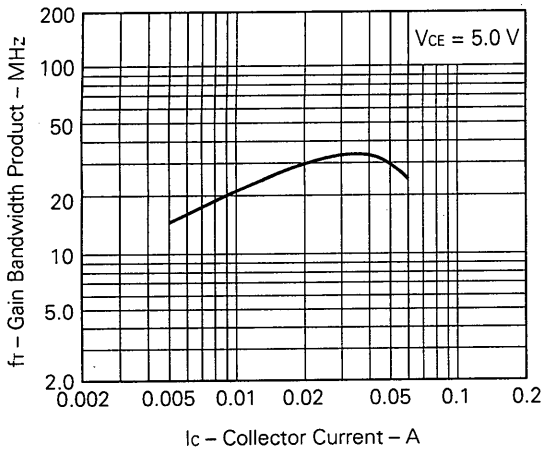

OUTPUT CAPACITANCE vs. COLLECTOR TO BASE VOLTAGE

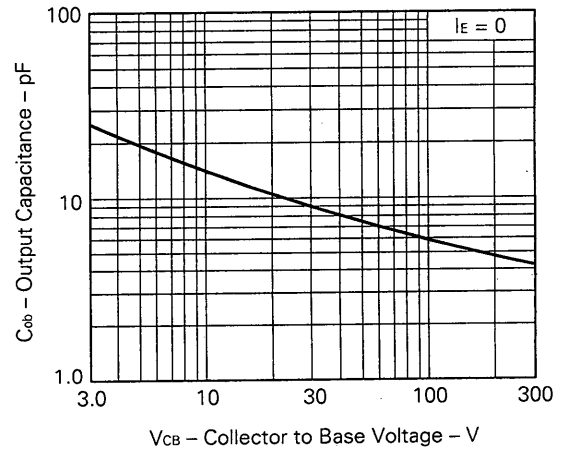

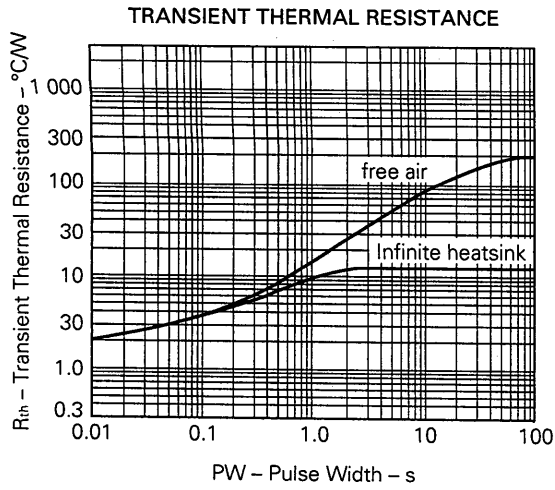

Reference

Application note name	No.
Quality control of NEC semiconductors devices.	TEI-1202
Quality control guide of semiconductors devices.	MEI-1202
Assembly manual of semiconductors devices.	IEI-1207
Design of Push-Pull Type Switching Regulators (Basic)	TEB-1002
Design of Push-Pull Type Switching Regulators (Applications)	TEB-1003
Optimum Base Drive Conditions of Switching Power Transistors	TEB-1014

[MEMO]

[MEMO]

No part of this document may be copied or reproduced in any form or by any means without the prior written consent of NEC Corporation. NEC Corporation assumes no responsibility for any errors which may appear in this document.

NEC Corporation does not assume any liability for infringement of patents, copyrights or other intellectual property rights of third parties by or arising from use of a device described herein or any other liability arising from use of such device. No license, either express, implied or otherwise, is granted under any patents, copyrights or other intellectual property rights of NEC Corporation or others.

The devices listed in this document are not suitable for use in aerospace equipment, submarine cables, nuclear reactor control systems and life support systems. If customers intend to use NEC devices for above applications or they intend to use "Standard" quality grade NEC devices for applications not intended by NEC, please contact our sales people in advance.

Application examples recommended by NEC Corporation.

Standard: Computer, Office equipment, Communication equipment, Test and Measurement equipment, Machine tools, Industrial robots, Audio and Visual equipment, Other consumer products, etc.

Special: Automotive and Transportation equipment, Traffic control systems, Antidisaster systems, Anticrime systems, etc.